

INSTALLATION MANUAL

GPR SERIES

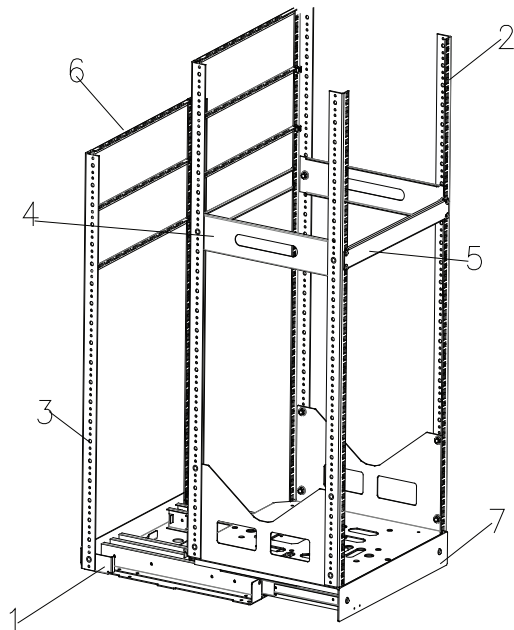

PARTS LIST

- 1) Rotating rack base (1x)
- 2) Front & rear rack mounting rails (4x)
- 3) Base rack mounting rails (2x)
- 4) Front & rear connection panel (2x)
- 5) 19" 1U blind panel (2x)
- 6) Cable lacing bars (6x)
- 7) Front lock cover panel (1x)

ACCESSORIES

①	②	③	④
M8	M6		M6x12
x14	x20	x20	x22

STEP 1

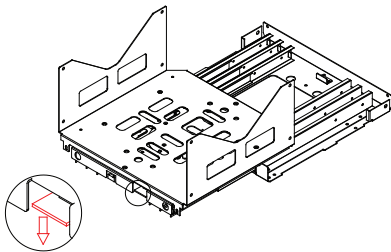

Extract the slide-out platform from the base by pressing the locking tab downwards and pulling it.

STEP 2

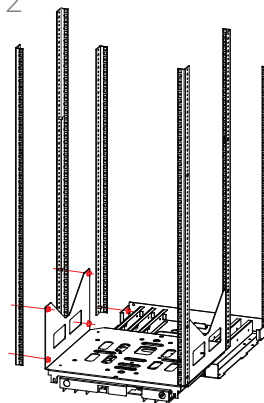

Install the vertical front (4x) and rear (2x) vertical rails to the base using M8 hex flange nuts (10x).

STEP 3

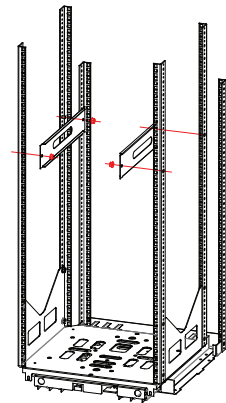

Install both front & rear connection panels using M8 hex flange nuts (4x).

STEP 4

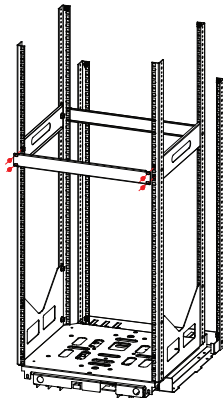

Install the 19" 1U blind panels on the front and rear side using 8 x M6 cage nuts and M6 x 12 pan head screws.

STEP 5

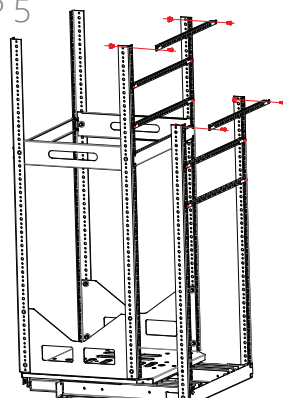

Install the cable lacing bars on the rear vertical rails and base vertical rails using 12 x M6 cage nuts and M6 x 12 pan head screws.

STEP 6

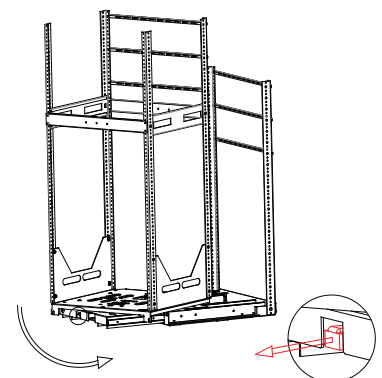

Pull out the lock from the slide-out platform to rotate the platform. It can be locked in 45° and 90° position.

INSTALLATION MANUAL

GPR SERIES



STEP 7

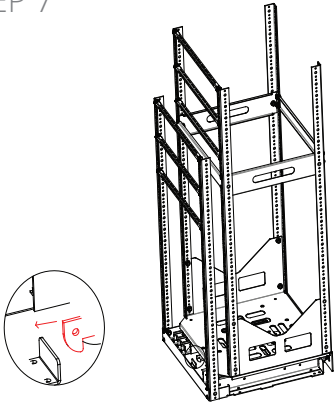

Install the equipment into the rack, wire it up and push the slide out platform back into the base. It will lock automatically when inserted.

STEP 8

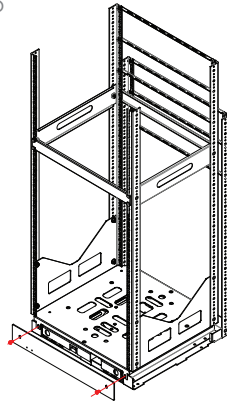

Assemble the front lock cover panel to secure the slide out platform to the base and cover the locking tabs.

STEP 9

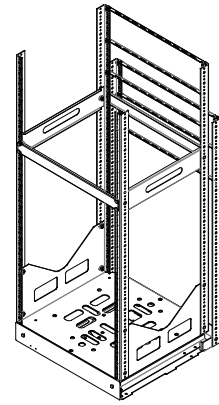

The rack is now well installed and ready for use.

ATTENTION

To guarantee proper functionality of the slide-out system, it is important that the GPR rack is secured to the supporting floor or platform. The fasteners for securing are depending of the type of supporting surface and are not included with delivery of the rack.