

MRM-70R/MRM-70B DIVERSITY RECEIVER MODULE



INTRODUCTION

The MRM-70R/MRM-70B is a remote controllable diversity receiver module suitable for installation in most MIPRO portable PA amplifiers. It can also be fitted to other PA amplifiers, mixers, signal processors and karaoke players to provide these devices with frequency agile, wireless reception.

The UHF band and PLL technology are utilized to avoid the often congested VHF band. True diversity and advanced circuitry combine to eliminate signal dropouts and random noise interference.

PART NAMES AND FUNCTIONS

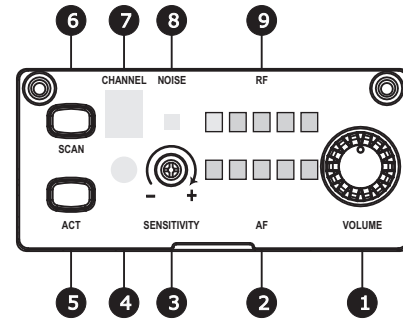

- 1 Receiver Power Switch/Volume Control:** Turns on/off of receiver. After power on, AF LED will flash. Turn knob clockwise to turn up volume.
- 2 Audio Signal Meter:** Indicate the audio signal level.
- 3 Sensitivity Adjuster:** Higher sensitivity (+) to increase receiving distance. Lower sensitivity (-) to minimize noise interference.
Note: lower sensitivity level also reduces operating distance.
- 4 ACT Infrared (IR) Port:** Transmits IR signal to transmitter to synchronize frequencies.
- 5 ACT Sync Button:** Press to synchronize the receiver and transmitter frequencies.
- 6 SCAN Button:** Press for an interference-free channel.
- 7 LED Screen:** Displays current receiver channel.
- 8 Noise Indicator:** When lit, it denotes the presence of interference.
- 9 RF Signal Meter:** Indicate the RF signal strength received when transmitter is turned on.

SET-UP RECEIVER AND TRANSMITTER FREQUENCIES AUTOMATIC "RECEIVER" FREQUENCY SELECTION

1. POWER "ON" the portable PA.



2. POWER on receiver by turning "VOLUME" knob.

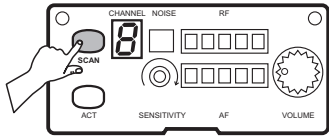

3. Press & hold "SCAN" button for 1 second

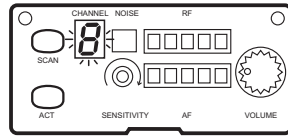

4. Existing channel blinks

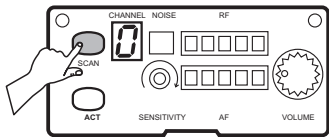

5. Press & release "SCAN" button

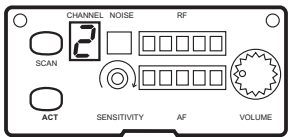

6. New interference-free channel appears

AUTOMATIC "TRANSMITTER" SYNC

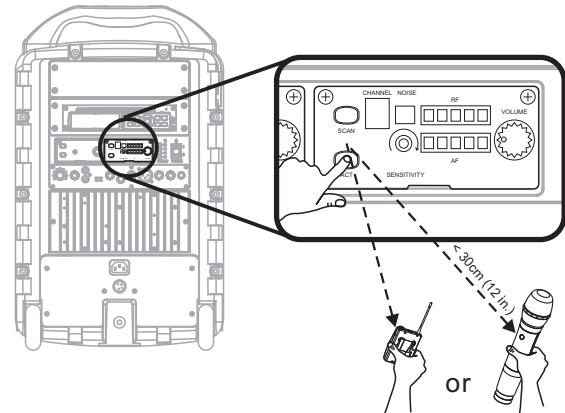

1. POWER on transmitter (ensure fresh batteries are properly installed with the correct polarity). Replace transmitter battery when LED glows red during powered-on. (glows red = low battery)
2. Locate and bring an ACT transmitter *infrared (IR) port within 30cm (12-inch) of receiver's ACT button.
3. Press and release "ACT" button to synchronize transmitter and receiver frequencies.
4. When the frequencies are synchronized successfully the receiver channel stops flashing and the RF meter is fully lit, the microphone is now ready for use.

NOTE: The transmitter infrared IR port is normally located by a round-shaped red color spot.

RECEIVER MODULE WIRING DIAGRAM

To install the receiver, simply follow the wiring diagram. Carefully align the edge connector and push the receiver module in to place. Then fasten the two locking screws.

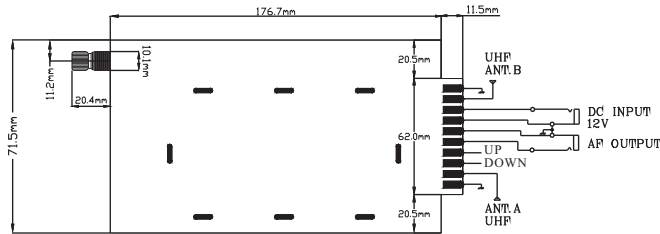

FC & IC - ID

THIS DEVICE COMPLIES WITH PART15 OF THE FCC RULES AND RSS-123 ISSUE1 OF CANADA. OPERATION IS SUBJECT TO THE FOLLOWING TWO CONDITIONS:

- (1) This device may not cause interference.
- (2) This device must accept any interference, including interference that may cause undesired operation of the device. This equipment complies with FCC RF radiation exposure limits set forth for an uncontrolled environment.

Disposal



2005-08-13

Dispose of any unusable devices or batteries responsibly and in accordance with any applicable regulations.

Disposing of used batteries with domestic waste is to be avoided!

Batteries/NiCad cells often contain heavy metals such as cadmium(Cd), mercury(Hg) and lead(Pb) that makes them unsuitable for disposal with domestic waste. You may return spent batteries/ accumulators free of charge to recycling centres or anywhere else batteries/ accumulators are sold.

By doing so, you contribute to the conservation of our environment!
